

Description

The DM4035 is an ultra wideband 1-to-4 active power splitter fabricated using a 0.1 mm HBT GaAs technology. It is based on an ECL topology in order to guarantee high-speed operations.

The device is capable of replicating NRZ streams with data rate up to 12.5Gb/s or clock signal with frequency up to 12.5GHz.

The inputs and the outputs are DC coupled. At the input side the internal 50 ohm resistors avoid the need for external impedance matching terminations. The DM4035 uses SCFL I/O levels and is designed so to allow for either single ended or differential data input. is an ultra-wideband phase delay fabricated using 1-um HBT GaAs technology and is based on ECL topology to guarantee high-speed operation. The large output voltage, excellent rise and fall time and the good quality of the eye diagram at all data rates up to 12.5Gb/s makes the DM4035 suitable for data and clock distribution at a very high speed. Complex digital applications may benefit from the DM4035: as an example clock and data distribution.

Features

- ❖ Ultra wideband: Up to 12.5 Gb/s NRZ
- ❖ High Input sensitivity: 300mV single ended
- ❖ 900 mVpp single-ended output
- ❖ Jitter RMS: <1.5 ps
- ❖ Output rise time (20% – 80 %): <20 ps
- ❖ Output fall time (20% – 80 %): <17 ps
- ❖ 50-ohm matched DC-coupled inputs and outputs
- ❖ Differential or single ended I/O
- ❖ Power consumption: 2.0 W

Device Diagram

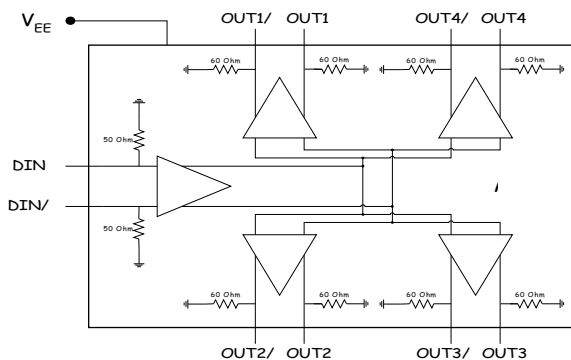

Timing Diagram

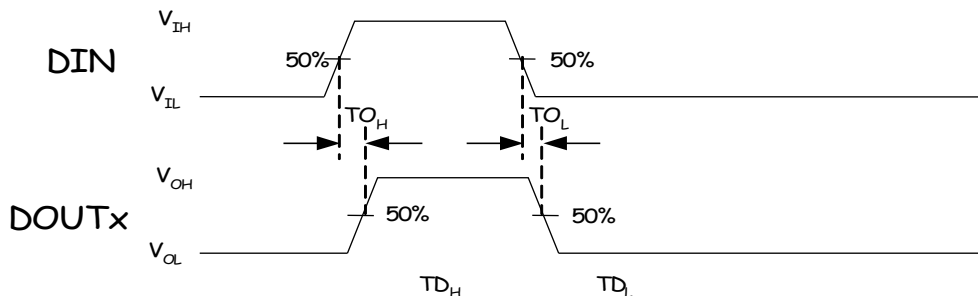



DM4035

1:4 Power Splitter

(preliminary information)

Absolute Maximum Ratings

Stresses above those listed under Absolute Maximum Ratings may cause permanent damage to the device. This is a stress rating only; functional operation of the device at these or any other conditions above those indicated in the operational section of this document is not implied. Exposure to absolute maximum rating conditions for extended periods may affect device reliability.

Symbol	Parameters/conditions	Min.	Max.	Units
VEE	Power supply voltage	-5.5	0	V
VIH	Input voltage level, high level	-1.5	1.5	V
VIL	Input voltage level, low level	-1.5	1.5	V
VC	Delay control voltage	-5.0	0	V
TA	Operating temperature range – die	-15	125	°C
TSTG	Storage temperature	-65	150	°C

Recommended Operating Conditions

Symbol	Parameters/Conditions	Min.	Typ.	Max.	Units
TA	Operating Temperature Range – Die	0		85	°C
V _{EE}	Power supply voltage		-5		V
V _{IH}	Input voltage level, HIGH level (Single Ended)		0.0		V
V _{IL}	Input voltage level, LOW level (Single Ended)		-0.9		V

Electrical Characteristics

1. Electrical characteristics at ambient temperature.
2. In case of single-ended input, the unused pad must be tied to V_{INDC}.
3. In case of single-ended output, the unused pad must be terminated with 50 ohms to ground.
4. On a 12.5 Gb/s PRBS pattern.

Symbol	Parameters	Min	Typ	Max	Units
V _{EE}	Power supply voltage	-4.5	-5.00	-5.25	V
V _{IH}	Input voltage level, HIGH level (Single ended)		0.0		V
V _{IL}	Input voltage level, LOW level (Single ended)		-0.9		V
V _{INDC}	DC input voltage (with DC-coupled input [†])		-0.45		V
V _{OUT}	Data output voltage amplitude [‡]	0.8	0.9	1.0	V
T _R	Output rise time (20% – 80 %)		20		ps
T _F	Output fall time (20% – 80 %)		17		ps
S ₁₁	Input return Loss (up to 15GHz)		20		dB
S ₂₂	Output return Loss (up to 15GHz)		8		dB
F _{MAX}	Maximum Clock frequency		12.5		GHz
J _{P-P}	Peak-to-Peak Jitter [§]		9		ps
J _{rms}	RMS Jitter [§]		1.5		ps
I _{EE}	Power supply current		400		mA
P _D	Power dissipation		2.0		W

Eye Diagram Performance

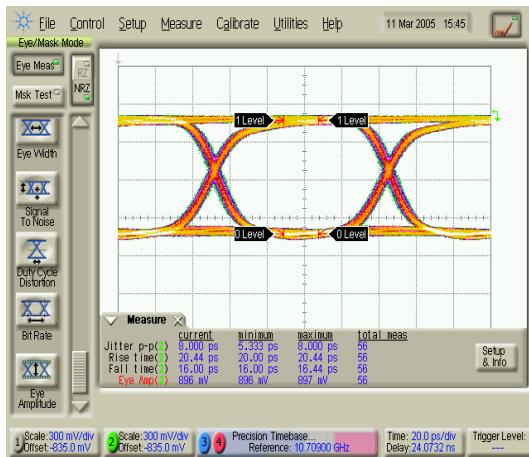

Die Measurement

VEE: -5V

Input Data Rate **10.7 Gb/s**

Single ended Data Input (0/-500mV)

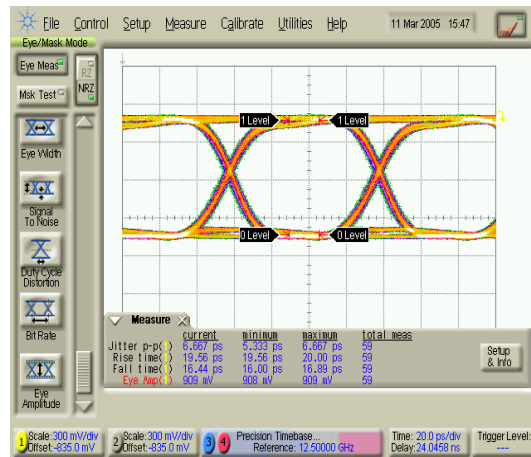

Die Measurement

VEE: -5V

Input Data Rate **12.5 Gb/s**

Single ended Data Input (0/-500mV)

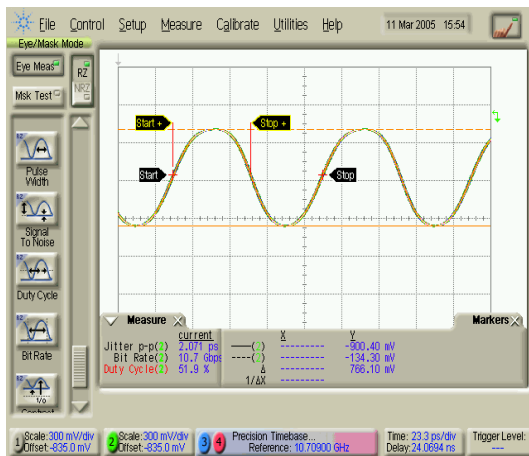

Die Measurement

VEE: -5V

Input Clock Frequency **10.7GHz**

Differential Data Input (0/-500mV)

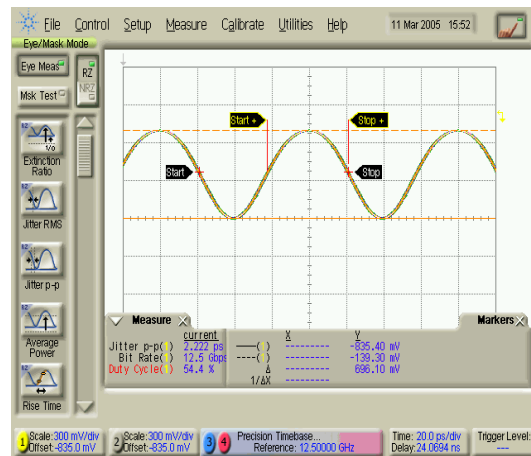

Die Measurement

VEE: -5V

Input Clock Frequency **12.5GHz**

Single ended Data Input (0/-500mV)

Die Pinout and dimensions

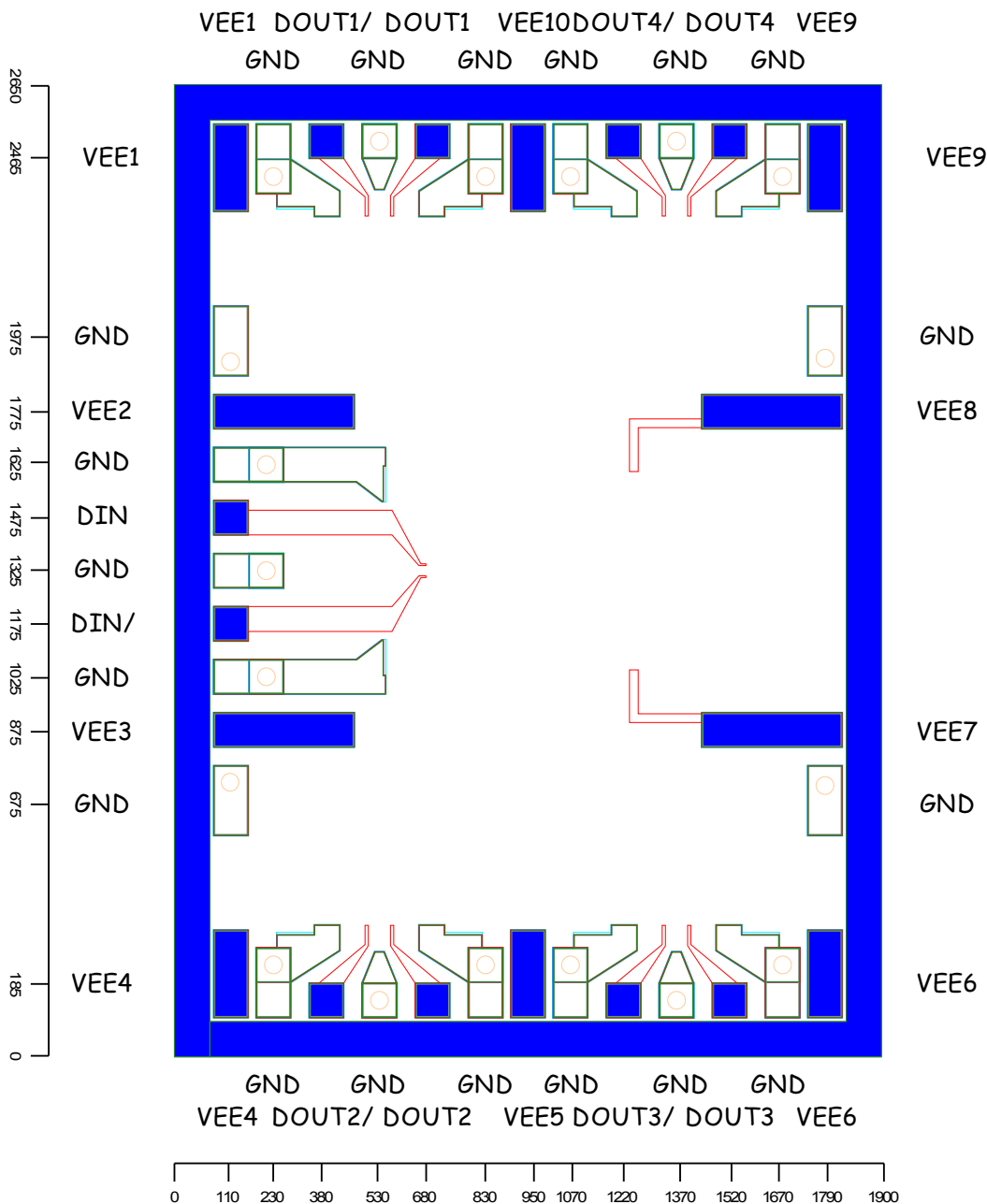

Recommended chip assembly

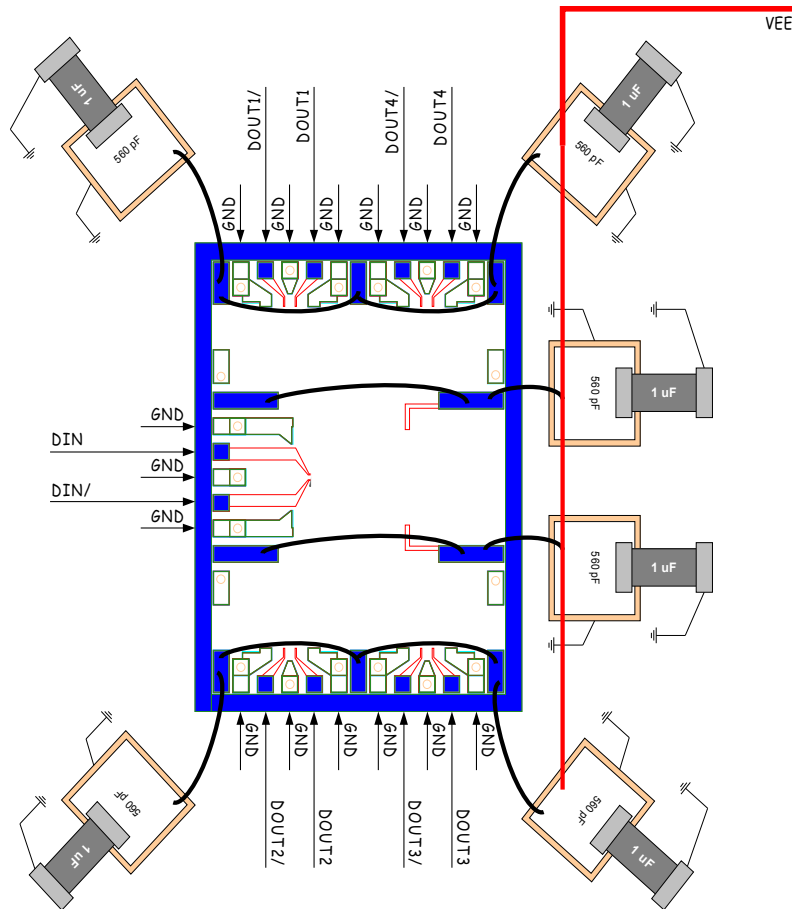

Disclaimer

DIGIMIMIC RESERVES THE RIGHT TO MAKE CHANGES WITHOUT FURTHER NOTICE TO ANY PRODUCTS HEREIN TO IMPROVE RELIABILITY, FUNCTION OR DESIGN. DIGIMIMIC DOES NOT ASSUME ANY LIABILITY ARISING OUT OF THE APPLICATION OR USE OF ANY PRODUCT OR CIRCUIT DESCRIBED HEREIN; NEITHER DOES IT CONVEY ANY LICENSE UNDER ITS PATENT RIGHTS, NOR THE RIGHTS OF OTHERS.

Application Information

CAUTION: THIS IS AN ESD SENSITIVE DEVICE

Chip carrier material should be selected to have GaAs compatible thermal coefficient of expansion and high thermal conductivity such as copper molybdenum or copper tungsten. The chip carrier should be machined, finished flat, plated with gold over nickel and should be capable of withstanding 325°C for 15 minutes.

Die attachment for power devices should utilize Gold/Tin (80/20) eutectic alloy solder and should avoid hydrogen environment for HBT devices. Note that the backside of the chip is gold plated and it is connected to RF and DC Ground.

These GaAs devices should be handled with care and stored in dry nitrogen environment to prevent contamination of bonding surfaces. These are ESD sensitive devices and should be handled with appropriate precaution including the use of wrist-grounding straps. All die attach and wire/ribbon bond equipment must be well grounded to prevent static discharges through the device.

Recommended wire bonding: for Signal input / output connections, use either 3 mils wide and 0.5 mil thick gold ribbon or a pair of 1mil diameter wires with lengths as short as practical allowing for appropriate stress relief (typically 400 +/- 100 um long). For all other connections, a single 1 mil dia wire of appropriate minimum length may be used.

Product Status Definitions

Datasheet Identification	Product Status	Definition
Advanced Information	Formative or or In Design	This datasheet contains the design specifications for product development. Specifications may change in any manner without notice.
Preliminary	First Production	This datasheet contains preliminary data, and supplementary data will be published at a later date. DIGIMIMIC reserves the right to make changes at any time without notice in order to improve design.
No Identification Needed	Full Production	This datasheet contains final specifications. DIGIMIMIC reserves the right to make changes at any time without notice in order to improve design.
Obsolete	Not in Production	This datasheet contains specifications on a product that has been discontinued by DIGIMIMIC. The datasheet is printed for reference information only.